

MLA-80 ROTOR



**Used In Beckman Coulter
Optima™ MAX
and MAX-E Ultracentrifuges**



SAFETY NOTICE

This safety notice summarizes information basic to the safe use of the rotor described in this manual. The international symbol displayed above is a reminder to the user that all safety instructions should be read and understood before operation or maintenance of this equipment is attempted. When you see the symbol on other pages throughout this publication, pay special attention to the specific safety information presented. Observance of safety precautions will also help to avoid actions that could damage or adversely affect the performance of the rotor. This rotor was developed, manufactured, and tested for safety and reliability as part of a Beckman Coulter ultracentrifuge/rotor system. Its safety or reliability cannot be assured if used in a centrifuge not of Beckman Coulter's manufacture or in a Beckman Coulter ultracentrifuge that has been modified without Beckman Coulter's approval.



Handle body fluids with care because they can transmit disease. No known test offers complete assurance that such fluids are free of micro-organisms. Some of the most virulent—Hepatitis (B and C) viruses, HIV (I–V), atypical mycobacteria, and certain systemic fungi—further emphasize the need for aerosol protection. Handle other infectious samples according to good laboratory procedures and methods to prevent spread of disease. Because spills may generate aerosols, observe proper safety precautions for aerosol containment. Do not run toxic, pathogenic, or radioactive materials in this rotor without taking appropriate safety precautions. Biosafe containment should be used when Risk Group II materials (as identified in the World Health Organization *Laboratory Biosafety Manual*) are handled; materials of a higher group require more than one level of protection.



The rotor and accessories are not designed for use with materials capable of developing flammable or explosive vapors. Do not centrifuge such materials in nor handle or store them near the ultracentrifuge.



Although rotor components and accessories made by other manufacturers may fit in the MLA-80 rotor, their safety in this rotor cannot be ascertained by Beckman Coulter. Use of other manufacturers' components or accessories in the MLA-80 rotor may void the rotor warranty and should be prohibited by your laboratory safety officer. Only the components and accessories listed in this publication should be used in this rotor.



Make sure that filled containers are loaded symmetrically into the rotor and that opposing tubes are filled to the same level with liquid of the same density. Make sure that cavities in use have the proper spacers and/or floating spacers inserted before installing the rotor lid.



If disassembly reveals evidence of leakage, you should assume that some fluid escaped the rotor. Apply appropriate decontamination procedures to the centrifuge and accessories.



Never exceed the maximum rated speed of the rotor and labware in use. Refer to the section on RUN SPEEDS, and derate the run speed as appropriate.



Do not use sharp tools on the rotor that could cause scratches in the rotor surface. Corrosion begins in scratches and may open fissures in the rotor with continued use.

MLA-80 ROTOR

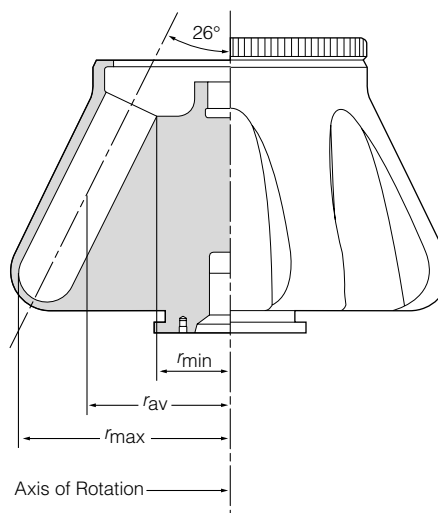

SPECIFICATIONS

Maximum speed	80 000 rpm
Density rating at maximum speed	1.2 g/mL
Relative Centrifugal Field* at maximum speed	
At r_{max} (61.9 mm)	$444\,000 \times g$
At r_{av} (45.7 mm)	$328\,000 \times g$
At r_{min} (29.5 mm)	$212\,000 \times g$
k factor at maximum speed	29
Conditions requiring speed reductions	see RUN SPEEDS
Number of tube cavities	8
Available tubes	see Table 1
Nominal tube dimensions (largest tube)	16×64 mm
Nominal tube capacity (largest tube)	8 mL
Nominal rotor capacity	64 mL
Approximate acceleration time to maximum	
speed (fully loaded)	10 min
Approximate deceleration time from maximum	
speed (fully loaded)	3 min
Weight of fully loaded rotor	2.06 kg (4.54 lb)
Rotor material	titanium

* Relative Centrifugal Field (RCF) is the ratio of the centrifugal acceleration at a specified radius and speed ($r\omega^2$) to the standard acceleration of gravity (g) according to the following formula:

$$RCF = \frac{r\omega^2}{g}$$

where r is the radius in millimeters, ω is the angular velocity in radians per second ($2\pi \text{ RPM} / 60$), and g is the standard acceleration of gravity (9807 mm/s^2). After substitution:

$$RCF = 1.12 r \left(\frac{\text{RPM}}{1000} \right)^2$$

DESCRIPTION

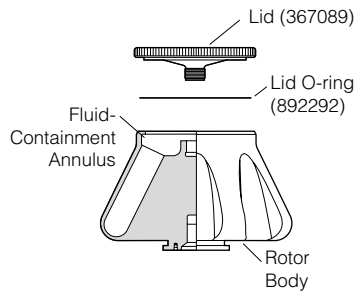

This Beckman Coulter rotor has been manufactured in an NSAI-registered ISO 9001 or 9002 facility for use with the appropriately classified Beckman Coulter ultracentrifuge.

The MLA-80 fixed angle rotor, rated for 80 000 rpm, has a tube angle of 26 degrees from the axis of rotation. The rotor can centrifuge up to eight tubes and is used in Beckman Coulter Optima™ MAX and MAX-E tabletop ultracentrifuges.

The rotor is made of titanium and is finished with black polyurethane paint. The lid is made of aluminum and anodized to resist corrosion. A rotor retention mechanism on the ultracentrifuge drive hub secures the rotor during the run. A lubricated O-ring made of Buna-N rubber maintains atmospheric pressure inside the rotor during centrifugation. The tube cavities are numbered to aid in sample identification.

The rotor is specially designed with a fluid-containment annulus located below the O-ring sealing surface. The annulus retains fluid that may escape from leaking or overfilled tubes, thereby preventing the liquid from escaping into the instrument chamber.

The ultracentrifuge identifies rotor speed during the run by means of a magnetic speed sensor in the instrument chamber and magnets on the bottom of the rotor. This overspeed protection system ensures that the rotor does not exceed its maximum permitted speed.

See the Warranty at the back of this manual for warranty information.

PREPARATION AND USE

Specific information about the MLA-80 rotor is given here. Information common to this and other rotors is contained in Rotors and Tubes for Tabletop Preparative Ultracentrifuges (publication TLR-IM), which should be used together with this manual for complete rotor and accessory operation. Publication TLR-IM is included in the literature package shipped with the rotor.

NOTE

Although rotor components and accessories made by other manufacturers may fit in the MLA-80 rotor, their safety in this rotor cannot be ascertained by Beckman Coulter. Use of other manufacturers' components or accessories in the MLA-80 rotor may void the rotor warranty and should be prohibited by your laboratory safety officer. Only the components and accessories listed in this publication should be used in this rotor.

PRERUN SAFETY CHECKS

Read the Safety Notice page at the front of this manual before using the rotor.

1. Inspect the O-ring and lid for damage—the high forces generated in this rotor can cause damaged components to fail.
2. Make sure to use only tubes and accessories listed in Table 1.
3. Check the chemical compatibilities of all materials used (refer to Appendix A in *Rotors and Tubes*).

ROTOR PREPARATION

For runs at other than room temperature, refrigerate or warm the rotor beforehand for fast equilibration.

1. Lightly but evenly lubricate metal threads with Spinkote™ lubricant (306812).
2. Apply a thin film of silicone vacuum grease (335148) to the O-ring in the rotor lid.
4. Load the filled and sealed (if applicable) tubes symmetrically into the rotor (see page 7 for tube information). If fewer than eight tubes are being run, they must be arranged symmetrically in the rotor (see Figure 1). *Opposing tubes must be filled to the same level with liquid of the same density.*

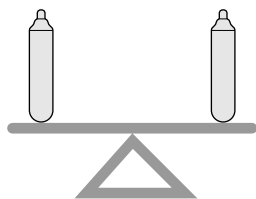

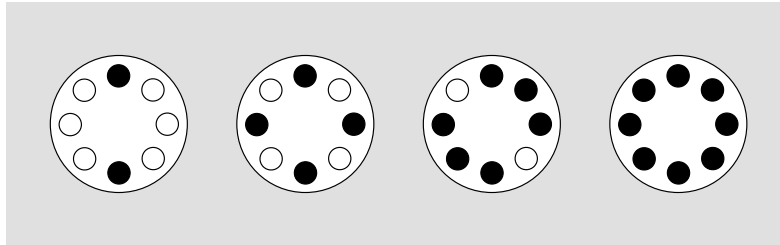

Figure 1. Arranging Tubes in the Rotor. Two, four, six, or eight tubes can be centrifuged per run if they are arranged in the rotor as shown.

5. Use the required spacers, if necessary (see Table 1), to complete the loading operation.
6. After the rotor is loaded, insert it into the portable polypropylene rotor vise (346133). Place the lid on the rotor and tighten it firmly to the right (clockwise) by hand. No tool is required.

OPERATION

1. Use an absorbent towel to wipe off condensation from the rotor.
2. Carefully place the rotor on the drive hub.
3. Refer to the instrument instruction manual for ultracentrifuge operation.
4. For additional operating information, see the following:
 - RUN TIMES, page 9, for using k factors to adjust run durations.
 - RUN SPEEDS, page 10, for information about speed limitations.
 - SELECTING CsCl GRADIENTS, page 14, for methods to avoid CsCl precipitation during centrifugation.

REMOVAL AND SAMPLE RECOVERY



CAUTION

If disassembly reveals evidence of leakage, you should assume that some fluid escaped the rotor. Apply appropriate decontamination procedures to the centrifuge and accessories.

1. Remove the rotor from the ultracentrifuge and place it in the rotor vise.
2. Remove the lid by unscrewing it to the left (counterclockwise).
3. Use a tube removal tool to remove the spacers and tubes.

TUBES AND ACCESSORIES

The MLA-80 rotor uses tubes and accessories listed in Table 1. Be sure to use only those items listed, and to observe the maximum speed limits shown. Refer to Appendix A in *Rotors and Tubes* for information on the chemical resistances of tube and accessory materials.

Temperature Limits

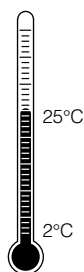

- Plastic tubes have been centrifuge tested for use at temperatures between 2 and 25°C. For centrifugation at other temperatures, pretest tubes under anticipated run conditions.
- If plastic containers are frozen before use, make sure that they are thawed to at least 2°C prior to centrifugation.

Table 1. Available Tubes for the MLA-80 Rotor.
Use only the items listed here and observe maximum fill volumes and speed shown.

Tube			Required Accessory		Max. Speed/ RCF/ k Factor
Dimensions and Volume	Description	Part Number	Description	Part Number	
16 × 58 mm 8 mL	Quick-Seal polyallomer	344621 (pkg/50)	Noryl* floating spacer	367094	80 000 rpm 444 000 × g 29
16 × 64 mm 6.5 mL	thickwall polyallomer	355646 (pkg/25)	none	—	35 000 rpm 84 900 × g 153
16 × 64 mm 6.5 mL	thickwall polycarbonate	355647 (pkg/25)	none	—	80 000 rpm 418 000 × g 19
16 × 45 mm 6.3 mL	Quick-Seal polyallomer	345830 (pkg/50)	Noryl floating spacer	367094	80 000 rpm 444 000 × g 23
16 × 38 mm 4.2 mL	Quick-Seal polyallomer	356562 (pkg/50)	Noryl floating spacer	367094	80 000 rpm 444 000 × g 18

• Noryl is a registered trademark of General Electric.

Quick-Seal® Tubes



Quick-Seal tubes must be sealed prior to centrifugation. These tubes are heat sealed and do not need caps; however, spacers are required on top of the tubes when they are loaded into the rotor.

- Fill Quick-Seal tubes leaving a *small* bubble of air at the base of the neck. Do not leave a large air space—too much air can cause excessive tube deformation.
- Refer to *Rotors and Tubes* for detailed information on the use and care of Quick-Seal tubes.

Some of the tubes listed in Table 1 are part of the g-Max™ system. The g-Max system uses a combination of small bell-top Quick-Seal tubes and floating spacers (also called g-Max spacers). This means that you can run the shorter tubes listed in the table in the MLA-80 rotor without reduction in g force. Additional information about the g-Max system is available in publication DS-709.

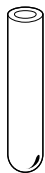

Thickwall Tubes

Thickwall polyallomer and polycarbonate tubes can be run partially filled (at least half filled) without caps, but all opposing tubes for a run must be filled to the same level with liquid of the same density. Do not overfill capless tubes.

RUN TIMES

TIME HR:MIN

03:30

The k factor of the rotor is a measure of the rotor's pelleting efficiency. (Beckman Coulter has calculated the k factors for all of its preparative rotors at maximum rated speed and using full tubes.) The k factor is calculated from the formula:

$$k = \frac{\ln(r_{\max}/r_{\min})}{\omega^2} \times \frac{10^{13}}{3600} \quad (1)$$

where ω is the angular velocity of the rotor in radians per second ($\omega = 0.105 \times \text{rpm}$), r_{\max} is the maximum radius, and r_{\min} is the minimum radius.

After substitution:

$$k = \frac{(2.533 \times 10^{11}) \ln(r_{\max}/r_{\min})}{\text{rpm}^2} \quad (2)$$

Use the k factor in the following equation to estimate the run time t (in hours) required to pellet particles of known sedimentation coefficient s (in Svedberg units, S).

$$t = \frac{k}{s} \quad (3)$$

Run times can be estimated for centrifugation at less than maximum speed by adjusting the k factor as follows:

$$k_{\text{adj}} = k \left(\frac{80\,000}{\text{actual run speed}} \right)^2 \quad (4)$$

Run times can also be estimated from data established in prior experiments if the k factor of the previous rotor is known. For any two rotors, a and b:

$$\frac{t_a}{t_b} = \frac{k_a}{k_b} \quad (5)$$

For more information on k factors see *Use of k Factor for Estimating Run Times from Previously Established Run Conditions* (publication DS-719).

RUN SPEEDS



The centrifugal force at a given radius in a rotor is a function of speed. Comparisons of forces between different rotors are made by comparing the rotors' relative centrifugal fields (RCF). When rotational speed is adjusted so that identical samples are subjected to the same RCF in two different rotors, the samples are subjected to the same force. The RCF at a number of rotor speeds is provided in Table 2.

Speeds must be reduced under the following circumstances:

1. If nonprecipitating solutions more dense than 1.2 g/mL are centrifuged, the maximum allowable run speed must be reduced according to the following equation:

$$\text{reduced maximum speed} = (80\,000 \text{ rpm}) \sqrt{\frac{1.2 \text{ g/mL}}{\rho}} \quad (6)$$

where ρ is the density of the tube contents. This speed reduction will protect the rotor from excessive stresses due to the added tube load. *Note, however, that the use of this formula may still produce maximum speed values that are higher than the limitations imposed by the use of certain tubes or adapters.* In such cases, use the lower of the two values.

2. *Further speed limits must be imposed* when CsCl or other self-forming-gradient salts are centrifuged, as equation (6) does not predict concentration limits/speeds that are required to avoid precipitation of salt crystals. Precipitation during centrifugation would alter the density distribution of CsCl and this would change the position of the sample bands. Figures 2 and 3, together with the description and examples below, show how to reduce run speeds when using CsCl gradients.

Table 2. Relative Centrifugal Fields for the MLA-80 Rotor.
 Entries in this table are calculated from the formula
 $RCF = 1.12r (RPM/1000)^2$ and then rounded to three significant digits.

Rotor Speed (rpm)	Relative Centrifugal Field (× g)			k Factor*
	At r_{max} (61.9 mm)	At r_{av} (45.7 mm)	At r_{min} (29.5 mm)	
80 000	444 000	328 000	212 000	29
75 000	390 000	288 000	186 000	33
70 000	340 000	251 000	162 000	38
65 000	293 000	216 000	140 000	44
60 000	250 000	184 000	119 000	52
55 000	210 000	155 000	100 000	62
50 000	173 000	128 000	66 900	75
45 000	141 000	104 000	52 900	93
40 000	111 000	81 900		117
35 000	84 900	62 700	40 500	153
30 000	62 400	46 100	29 700	209
25 000	43 300	32 000	20 700	300
20 000	27 700	20 500	13 200	469

*Calculated for all Beckman Coulter preparative rotors as a measure of the rotor's relative efficiency in pelleting sample in water at 20°C.

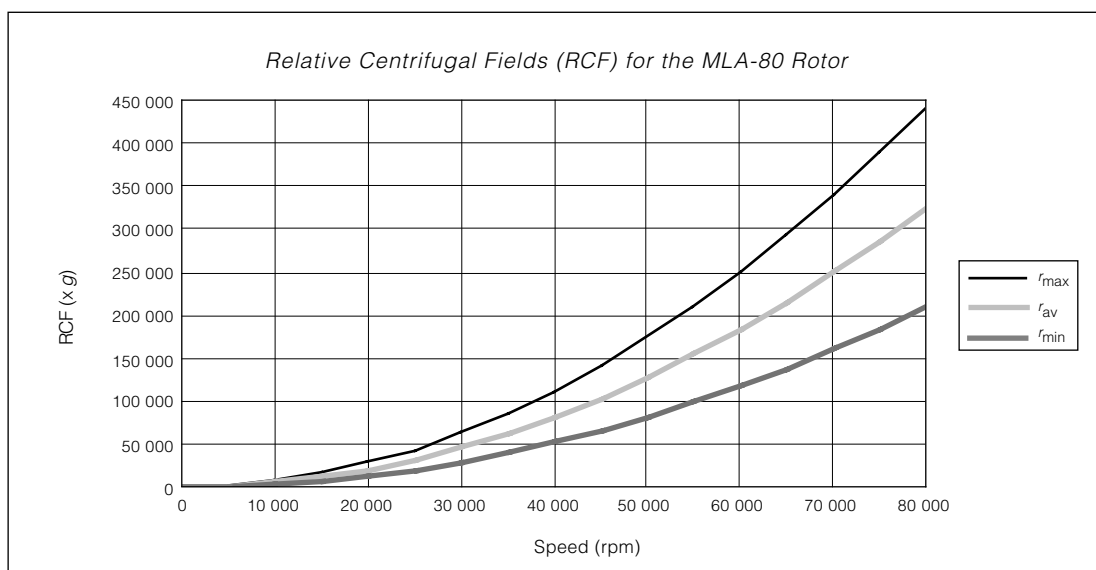

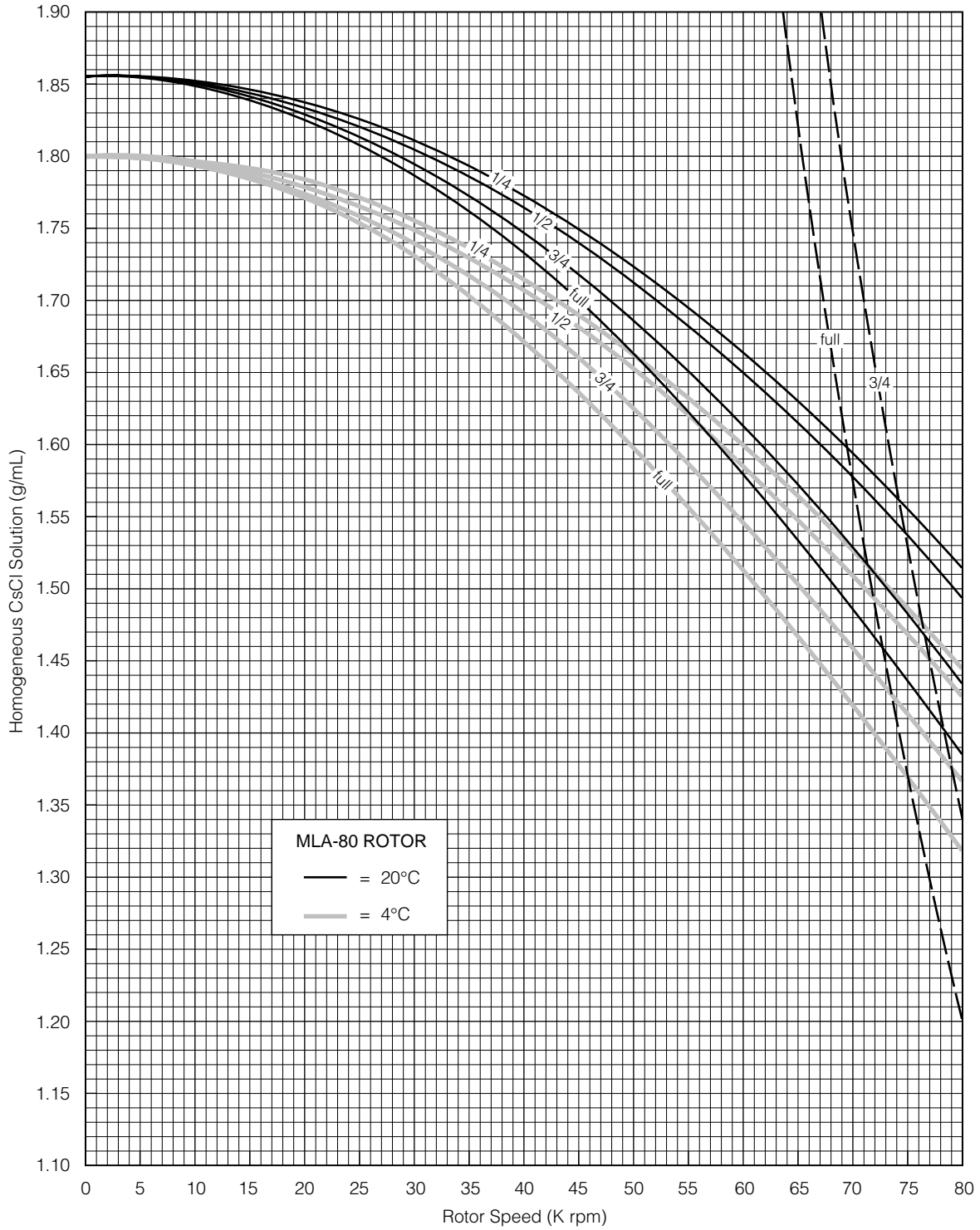

Figure 2. Precipitation Curves for the MLA-80 Rotor. Using combinations of rotor speeds and homogeneous CsCl solution densities that intersect on or below these curves ensures that CsCl will not precipitate during centrifugation. The dashed lines represent equation (6) and are shown here to illustrate the inability of that equation to predict CsCl precipitation.

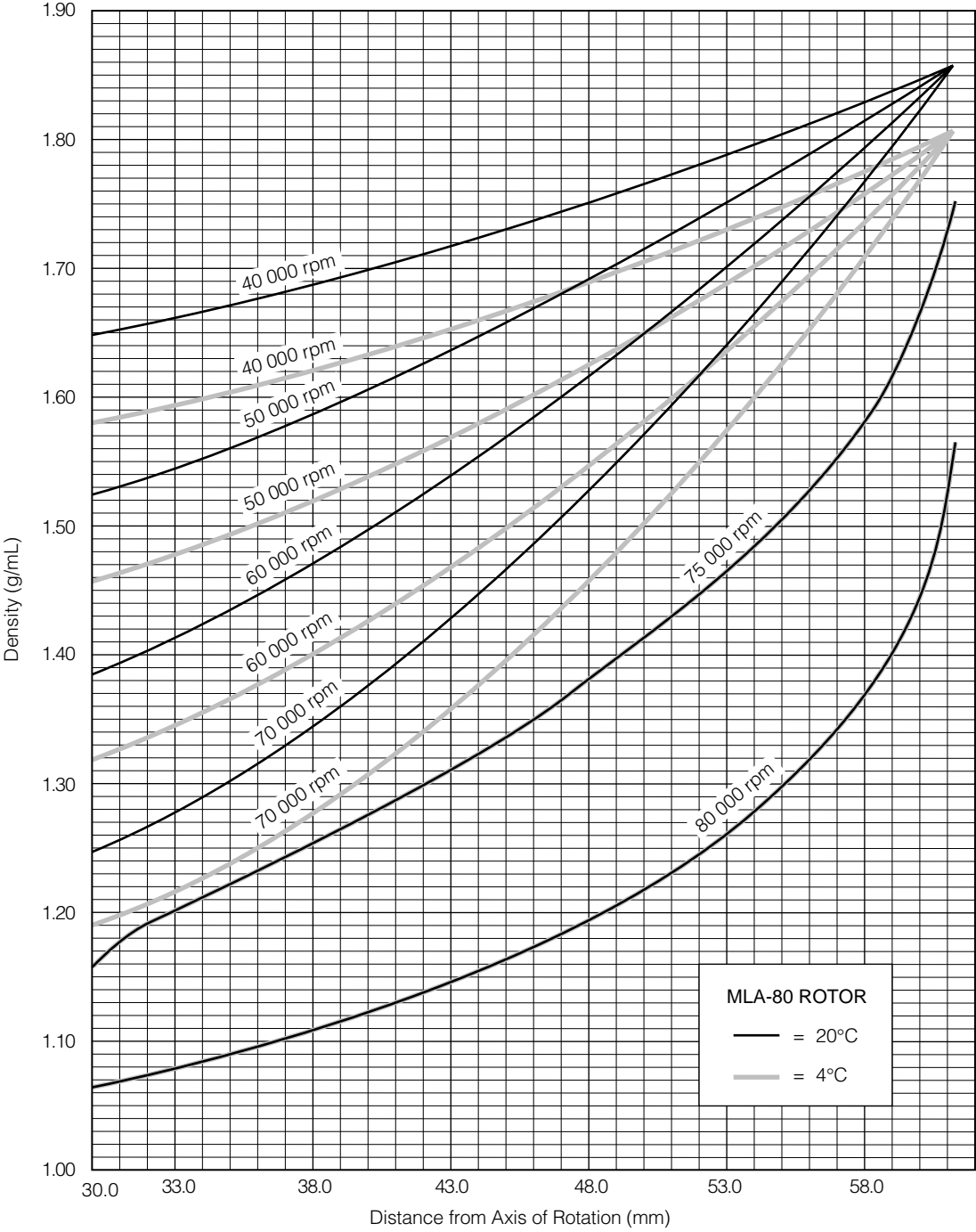
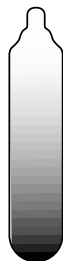

Figure 3. CsCl Gradients at Equilibrium for the MLA-80 Rotor. Centrifugation of homogeneous CsCl solutions at the maximum allowable speeds (from Figure 2) results in gradients presented here.

SELECTING CsCl GRADIENTS



Precipitation during centrifugation would alter density distribution, and this would change the position of the sample bands. Curves in Figures 2 and 3 are provided up to the maximum rated speed of the rotor.

NOTE

The curves in Figures 2 and 3 are for solutions of CsCl salt dissolved in distilled water only. If other salts are present in significant concentrations, the overall CsCl concentration may need to be reduced.

Rotor speed is used to control the slope of a CsCl density gradient, and must be limited so that CsCl precipitation is avoided. Speed and density combinations that intersect on or below the curves in Figure 2 ensure that CsCl will not precipitate during centrifugation in the MLA-80 rotor. Curves are provided at two temperatures: 20°C (black curves) and 4°C (gray curves).

The reference curves in Figure 3 show gradient distribution at equilibrium. Each curve in Figure 3 is within the density limits allowed for the MLA-80 rotor: each curve was generated for a single run speed using the maximum allowable homogeneous CsCl densities (one for each fill level) that avoid precipitation at that speed. (The gradients in Figure 3 can be generated from step or linear gradients, or from homogeneous solutions. But the total amount of CsCl in solution must be equivalent to a homogeneous solution corresponding to the concentrations specified in Figure 2.) Figure 3 can also be used to approximate the banding positions of sample particles. Gradient curves not shown in Figure 3 can be interpolated.

TYPICAL EXAMPLES FOR DETERMINING CsCl RUN PARAMETERS

Example A: A separation that is done frequently is the banding of plasmic DNA in cesium chloride with ethidium bromide. The starting density of the CsCl solution is 1.55 g/mL. In this separation the covalently closed, circular plasmid bands at a density of 1.57 g/mL, while the nicked and linear species band at 1.53 g/mL. At 20°C, where will particles band?

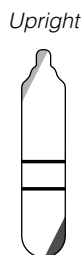
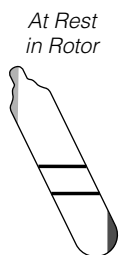
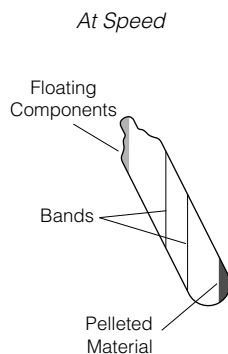

1. In Figure 2, find the curve that corresponds to the desired run temperature (20°C) and fill volume (full). The maximum allowable rotor speed is determined from the point where this curve intersects the homogeneous CsCl density (63 000 rpm).
2. In Figure 3, sketch in a horizontal line corresponding to each particle's buoyant density.
3. Mark the point in the figure where each particle density intersects the curve corresponding to the selected run speed and temperature.
4. Particles will band at these locations across the tube diameter at equilibrium during centrifugation.

In this example, particles will band about 44.0 and 46.5 mm from the axis of rotation, about 2.5 mm of centerband-to-centerband separation at the rotor's 26-degree tube angle. When the tube is held upright, there will be about 2.8 mm of centerband-to-centerband separation. This interband distance, d_{up} , can be calculated from the formula:

$$d_{up} = \frac{d_{\theta}}{\cos \theta} \tag{7}$$

where d_{θ} is the interband distance when the tube is held at an angle, θ , in the rotor.

Example B: Knowing particle buoyant densities (such as, 1.59 and 1.54 g/mL), how do you achieve good separation?

1. In Figure 3, sketch in a horizontal line corresponding to each particle's buoyant density.
2. Select the curve at the desired temperature (4°C) that gives the best particle separation.
3. Note the run speed along the selected curve (50 000 rpm).
4. From Figure 2, select the maximum homogeneous CsCl density (in this case, 1.60 g/mL) that corresponds to the temperature and run speed established above. These parameters will provide the particle-banding pattern selected in Step 2.

In this example, particles will band at about 45.0 and 40.0 mm from the axis of rotation (about 5.0 mm apart). When the tube is held upright there will be about 5.6 mm of center-of-band to center-of-band separation.

CARE AND MAINTENANCE

MAINTENANCE

NOTE

Do not use sharp tools on the rotor that could cause scratches in the rotor surface. Corrosion begins in scratches and may open fissures in the rotor with continued use.

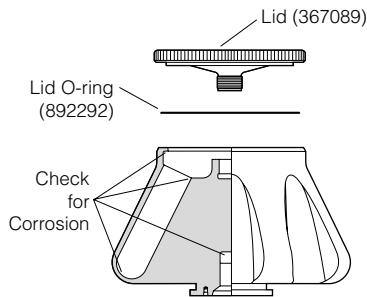

- Regularly lubricate the metal threads in the rotor with a thin, even coat of Spinkote lubricant (306812). Failure to keep these threads lubricated can result in damaged threads.
- Regularly apply silicone vacuum grease to the O-ring. Replace the O-ring about twice a year or whenever worn or damaged.

Refer to Appendix A in *Rotors and Tubes* for the chemical resistances of rotor and accessory materials. Your Beckman Coulter representative provides contact with the Field Rotor Inspection Program and the rotor repair center.

CLEANING

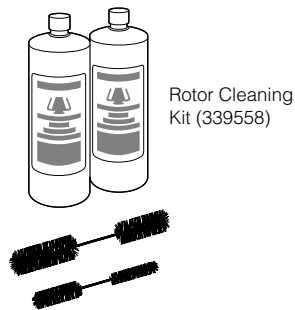

Wash the rotor and rotor components immediately if salts or other corrosive materials are used or if spillage has occurred. Do not allow corrosive materials to dry on the rotor.

Under normal use, wash the rotor frequently (at least weekly) to prevent buildup of residues.

1. Remove the O-ring before washing.
2. Wash the rotor and lid in a mild detergent, such as Beckman Solution 555™ (339555), that won't damage the rotor. The Rotor Cleaning Kit contains two plastic-coated brushes and two quarts of Solution 555 for use with rotors and accessories. Dilute the detergent 10 to 1 with water.

NOTE

Do not wash rotor components in a dishwasher. Do not soak in detergent solution for long periods, such as overnight.

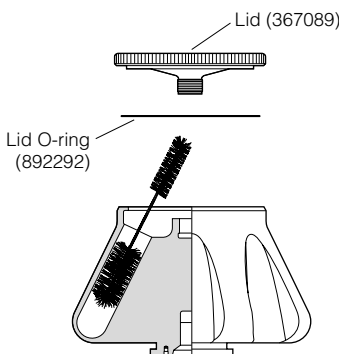

3. Rinse the cleaned rotor and components with distilled water.
4. Air-dry the rotor and lid upside down. *Do not use acetone to dry the rotor.*
5. Apply a thin, even coat of silicone vacuum grease to the lid O-ring before replacing it in the groove in the lid.

Clean metal threads as necessary (at least every 6 months). Use a brush and concentrated Solution 555. Rinse and dry thoroughly, then lubricate lightly but evenly with Spinkote to coat all threads.

Periodically remove the O-ring and wipe clean as necessary. Clean the O-ring groove with a cotton-tipped swab. Reapply a light film of silicone vacuum grease.

DECONTAMINATION



If the rotor or other components are contaminated with radioactive, toxic, or pathogenic materials, follow appropriate decontamination procedures as outlined by appropriate laboratory safety guidelines and/or other regulations. Consult Appendix A in *Rotors and Tubes* to select an agent that will not damage the rotor.

STERILIZATION AND DISINFECTION

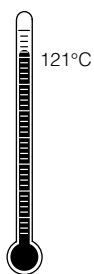

- The rotor and all rotor components can be autoclaved at 121°C for up to an hour. Remove the lid and O-ring from the rotor and place the rotor and lid in the autoclave upside down.
- Ethanol (70%)* or hydrogen peroxide (6%) may be used on all rotor components, including those made of plastic. Bleach (sodium hypochlorite) may be used, but may cause discoloration of anodized surfaces. Use the minimum immersion time for each solution, per laboratory standards.

While Beckman Coulter has tested these methods and found that they do not damage the rotor or components, no guarantee of sterility or disinfection is expressed or implied. When sterilization or disinfection is a concern, consult your laboratory safety officer regarding proper methods to use.

* Flammability hazard. Do not use in or near operating ultracentrifuges.

STORAGE

When it is not in use, store the rotor in a dry environment (not in the instrument) with the lid removed to allow air circulation so moisture will not collect in the tube cavities.

RETURNING A ROTOR

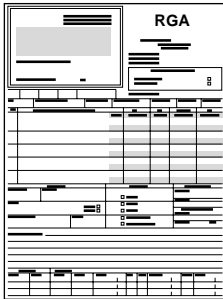

The image shows a Returned Goods Authorization (RGA) form. It has a header section with the title 'RGA' and several fields for information. Below the header is a table with multiple columns and rows, likely for tracking or recording return details.

Before returning a rotor or accessory for any reason, prior permission (a Returned Goods Authorization form) must be obtained from Beckman Coulter, Inc. This RGA form may be obtained from your local Beckman Coulter sales office, and should contain the following information:

- serial number,
- history of use (approximate frequency of use),
- reason for the return,
- original purchase order number, billing number, and shipping number, if possible,
- name and phone number of the person to be notified upon receipt of the rotor or accessory at the factory,
- name and phone number of the person to be notified about repair costs, etc.

To protect our personnel, it is the customer's responsibility to ensure that all parts are free from pathogens and/or radioactivity. Sterilization and decontamination must be done before returning the parts. Smaller items (such as tubes, bottles, etc.) should be enclosed in a sealed plastic bag.

*All parts must be accompanied by a note, plainly visible on the outside of the box or bag, stating that they are safe to handle and that they are not contaminated with pathogens or radioactivity. **Failure to attach this notification will result in return or disposal of the items without review of the reported problem.***

Use the address label printed on the RGA form when mailing the rotor and/or accessories to:

Beckman Coulter, Inc.
1050 Page Mill Road
Palo Alto, CA 94304
Attention: Returned Goods

Customers located outside the United States should contact their local Beckman Coulter office.

SUPPLY LIST

NOTE

To obtain copies of referenced publications, contact Beckman Coulter, Inc., Technical Publications Department, 1050 Page Mill Road, Palo Alto, CA 94304, U.S.A. (telephone 650-859-1753; fax 650-859-1375).

See the Beckman Coulter *Ultracentrifuge Rotors, Tubes & Accessories* catalog (BR-8101) or contact Beckman Coulter Sales (1-800-742-2345 in the United States; worldwide offices are listed on the back cover of this manual) for detailed information on ordering parts and supplies. For your convenience, a partial list is given below.

REPLACEMENT ROTOR PARTS

MLA-80 rotor assembly	367087
Lid	367089
Lid O-ring	892292
Rotor vise	346133

OTHER

Tubes and accessories	see Table 1
Quick-Seal Cordless Tube Topper kit, 60 Hz	358312
Quick-Seal Cordless Tube Topper kit, 50 Hz (Europe).	358313
Quick-Seal Cordless Tube Topper kit, 50 Hz (Great Britain).	358314
Quick-Seal Cordless Tube Topper kit, 50 Hz (Australia)	358315
Quick-Seal Cordless Tube Topper kit, 60 Hz (Canada)	367803
Tube Topper rack	348123
Floating spacer removal tool	338765
Tube removal tool	361668
Curved hemostat (6-in.)	927208
Straight hemostat (6-in.)	961519
Spinkote lubricant (2 oz)	306812
Silicone vacuum grease (1 oz)	335148
Rotor Cleaning Kit	339558
Rotor cleaning brush	347404
Beckman Solution 555 (1 qt)	339555

ULTRACENTRIFUGE ROTOR WARRANTY

All Beckman Coulter ultracentrifuge Fixed Angle, Vertical Tube, Near Vertical Tube, Swinging Bucket, and Airfuge rotors are warranted against defects in materials or workmanship for the time periods indicated below, subject to the Warranty Conditions stated below.

Preparative Ultracentrifuge Rotors 5 years — No Proration

Analytical Ultracentrifuge Rotors 5 years — No Proration

ML and TL Series Ultracentrifuge Rotors 5 years — No Proration

Airfuge Ultracentrifuge Rotors 1 year — No Proration

For Zonal, Continuous Flow, Component Test, and Rock Core ultracentrifuge rotors, see separate warranty.

Warranty Conditions (as applicable)

- 1) This warranty is valid for the time periods indicated above from the date of shipment to the original Buyer by Beckman Coulter or an authorized Beckman Coulter representative.
- 2) This warranty extends only to the original Buyer and may not be assigned or extended to a third person without written consent of Beckman Coulter.
- 3) This warranty covers the Beckman Coulter Centrifuge Systems only (including but not limited to the centrifuge, rotor, and accessories) and Beckman Coulter shall not be liable for damage to or loss of the user's sample, non-Beckman Coulter tubes, adapters, or other rotor contents.
- 4) This warranty is void if the Beckman Coulter Centrifuge System is determined by Beckman Coulter to have been operated or maintained in a manner contrary to the instructions in the operator's manual(s) for the Beckman Coulter Centrifuge System components in use. This includes but is not limited to operator misuse, abuse, or negligence regarding indicated maintenance procedures, centrifuge and rotor classification requirements, proper speed reduction for the high density of certain fluids, tubes, and tube caps, speed reduction for precipitating gradient materials, and speed reduction for high-temperature operation.
- 5) Rotor bucket sets purchased concurrently with or subsequent to the purchase of a Swinging Bucket Rotor are warranted only for a term co-extensive with that of the rotor for which the bucket sets are purchased.
- 6) This warranty does not cover the failure of a Beckman Coulter rotor in a centrifuge not of Beckman Coulter manufacture, or if the rotor is used in a Beckman Coulter centrifuge that has been modified without the written permission of Beckman Coulter, or is used with carriers, buckets, belts, or other devices not of Beckman Coulter manufacture.
- 7) Rotor parts subject to wear, including but not limited to rotor O-rings, VTi, NVT™, TLV, MLN, and TLN rotor tube cavity plugs and gaskets, tubing, tools, optical overspeed disks, bearings, seals, and lubrication are excluded from this warranty and should be frequently inspected and replaced if they become worn or damaged.
- 8) Keeping a rotor log is not mandatory, but may be desirable for maintenance of good laboratory practices.

Repair and Replacement Policies

- 1) If a Beckman Coulter rotor is determined by Beckman Coulter to be defective, Beckman Coulter will repair or replace it, subject to the Warranty Conditions. A replacement rotor will be warranted for the time remaining on the original rotor's warranty.
- 2) If a Beckman Coulter centrifuge is damaged due to a failure of a rotor covered by this warranty, Beckman Coulter will supply free of charge (i) all centrifuge parts required for repair (except the drive unit, which will be replaced at the then current price less a credit determined by the total number of revolutions or years completed, provided that such a unit was manufactured or rebuilt by Beckman Coulter), and (ii) if the centrifuge is currently covered by a Beckman Coulter warranty or Full Service Agreement, all labor necessary for repair of the centrifuge.
- 3) If a Beckman Coulter rotor covered by this warranty is damaged due to a malfunction of a Beckman Coulter ultracentrifuge covered by an Ultracentrifuge System Service Agreement, Beckman Coulter will repair or replace the rotor free of charge.
- 4) If a Beckman Coulter rotor covered by this warranty is damaged due to a failure of a Beckman Coulter tube, bottle, tube cap, spacer, or adapter, covered under the Conditions of this Warranty, Beckman Coulter will repair or replace the rotor and repair the instrument as per the conditions in policy point (2) above, and the replacement policy.
- 5) Damage to a Beckman Coulter rotor or instrument due to the failure or malfunction of a non-Beckman Coulter tube, bottle, tube cap, spacer, or adapter is not covered under this warranty, although Beckman Coulter will assist in seeking compensation under the manufacturer's warranty.

Disclaimer

IT IS EXPRESSLY AGREED THAT THE ABOVE WARRANTY SHALL BE IN LIEU OF ALL WARRANTIES OF FITNESS AND OF THE WARRANTY OF MERCHANTABILITY AND BECKMAN COULTER, INC. SHALL HAVE NO LIABILITY FOR SPECIAL OR CONSEQUENTIAL DAMAGES OF ANY KIND WHATSOEVER ARISING OUT OF THE MANUFACTURE, USE, SALE, HANDLING, REPAIR, MAINTENANCE, OR REPLACEMENT OF THE PRODUCT.

Factory Rotor Inspection Service

Beckman Coulter, Inc., will provide free mechanical and metallurgical inspection in Palo Alto, California, USA, of any Beckman Coulter rotor at the request of the user. (Shipping charges to Beckman Coulter are the responsibility of the user.) Rotors will be inspected in the user's laboratory if the centrifuge in which they are used is covered by an appropriate Beckman Coulter Service Agreement. Contact your local Beckman Coulter office for details of service coverage or cost.

Before shipping, contact the nearest Beckman Coulter Sales and Service office and request a Returned Goods Authorization (RGA) form and packaging instructions. Please include the complete rotor assembly, with buckets, lid, handle, tube cavity caps, etc. A SIGNED STATEMENT THAT THE ROTOR AND ACCESSORIES ARE NON-RADIOACTIVE, NON-PATHOGENIC, NON-TOXIC, AND OTHERWISE SAFE TO SHIP AND HANDLE IS REQUIRED.

Beckman Coulter Worldwide Bioresearch Division Offices

AUSTRALIA

Beckman Coulter Australia Pty Ltd
24 College Street, Unit D
Gladesville, NSW 2111
Australia
Telephone: (61) 2 9844-6000
or toll free: 1 800 060 880
Fax: (61) 2 9844-6096
email: myork@beckman.com

CANADA

Beckman Coulter (Canada) Inc.
6755 Mississauga Road, Suite 600
Mississauga, Ontario
Canada L5N 7Y2
Telephone: (905) 819-1234
Fax: (905) 819-1485

CHINA

Beckman Coulter Inc.
Beijing Representative Office
Unit 2005A, 2006-2009, East Ocean Center
Jian Guomenwai Avenue
Beijing 100022
China
Telephone: (86) 10 6515 6028
Fax: (86) 10 6515 6025, 6515 6026

**EASTERN EUROPE/
MIDDLE EAST/AFRICA**
Beckman Coulter International S.A.
22, Rue Juste-Olivier
Case Postale 301-303
CH-1260 Nyon, Switzerland
Telephone: (41) 22 994 07 07
Fax: (41) 22 994 07 00

FRANCE

Beckman Coulter France S.A.
Paris Nord II, 33/66 rue des Vanesses
B.P. 50359
Villepinte, France
95942 ROISSY CDG Cedex
Telephone: 01 49 90 90 00
Fax: 01 49 90 90 10
e-mail: bioresearch.france@beckman.com

GERMANY

Beckman Coulter GmBH
Siemensstrasse 1
D-85716 Unterschleissheim-Lohhof
Germany
Telephone: (89) 35870-0
Fax: (89) 35870-490
e-mail: bioresearch.de@beckman.com

HONG KONG

Beckman Coulter Hong Kong Ltd.
15th Floor, Gee Chang Hong Centre
65 Wong Chuk Hang Road
Aberdeen, Hong Kong
Telephone: (852) 2814 7431, 2814 0481
Fax: (852) 2814 1599, 2873 4511

ITALY

Beckman Coulter S.p.a.
Centro Direzionale Lambardo
Palazzo F/1, Via Roma 108
20060 Cassina de' Pecchi
Milano
Italy
Telephone: 02-953921
Fax: 02-95392264
e-mail: beckman_italia@beckman.com

JAPAN

Beckman Coulter K.K.
Toranomon 37 Mori Bldg.
3-5-1, Toranomon
Minato-ku, Tokyo 105-0001
Japan
Telephone: 03-5404-8395
Fax: 03-3578-4606

MEXICO

Beckman Coulter de Mexico
Calle Adolfo Prieto 1213
Colonia Del Valle
Mexico D.F.C.P.
Mexico 03100
Telephone: 525 559-16-35
Fax: 525 559-36-12

NETHERLANDS

Beckman Coulter Nederland B.V.
Nijverheidsweg 21
3641 RP-Mijdrecht
Postbus 47
3640 AA Mijdrecht
The Netherlands
Telephone: 0297-230630
Fax: 0297-288082

SINGAPORE

Beckman Coulter Singapore Pte. Ltd.
331 North Bridge Road
Odeon Towers, #07-01/02
Singapore 188720
Telephone: (65) 339 3633
Fax: (65) 336 6303

SOUTH AFRICA

Beckman Coulter
Stand 1A Fedsure Park
Tonetti Street
1685 Halfway House
Johannesburg
Republic of South Africa
Telephone: (27) 11-805-2014/5
Fax: (27) 11-805-4120

SPAIN

Beckman Coulter España S.A.
Avda. del Llano Castellano 15
28034 Madrid
Spain
Telephone: 91 728 7900
Fax: 91 728 7971

SWEDEN

Beckman Coulter AB
Archimedesvaegen 2
Box 11156
168 11 Bromma
Sweden
Telephone: 08-98 53 20
Telefax: 08-98 74 34

SWITZERLAND

Beckman Coulter International S.A.
22, Rue Juste-Olivier
Case Postale 301-303
CH-1260 Nyon
Switzerland
Telephone: 0800 850 810
Fax: 0848 850 810

TAIWAN

Beckman Coulter Taiwan Inc.
Taiwan Branch
8th Floor
216 Tun Hwa South Road, Section 2
Taipei 106, Taiwan
Republic of China
Telephone: (886) 2 2378 3456
Fax: (886) 2 2377 0408

UNITED KINGDOM

Beckman Coulter United Kingdom Ltd
Oakley Court
Kingsmead Business Park
London Road
High Wycombe
Bucks HP11 1JU
England, U.K.
Telephone: 01494 441181
Fax: 01494 447558
e-mail: beckman_uk@beckman.com

Authorized dealers in other countries.



Beckman Coulter, Inc. • 4300 N. Harbor Boulevard, Box 3100 • Fullerton, California 92834-3100
Sales: 1-800-742-2345 • Service: 1-800-551-1150 • Internet: www.beckmancoulter.com • Telex: 678413 • Fax: 1-800-643-4366



Printed on recycled paper

©1999 Beckman Coulter, Inc.



I.S. EN ISO 9001